

Lodes *Preview*

ed. 2023

LODES

2023 Preview

Part 1–New Concept Elara *design by* Nika Zupanc and Hover *design by* YOY Studio

Part 2–New Finish on Glass Random and Random Solo *design by* Chia–Ying Lee.

Lodes, via Pialoi 32,
30020 Marcon (Venezia) Italy
T +39 041 45 69 266
info@lodes.com – lodes.com

2023 Preview

from *Venice* since 1950

New Concept: *Elara* NEW LAMP

01

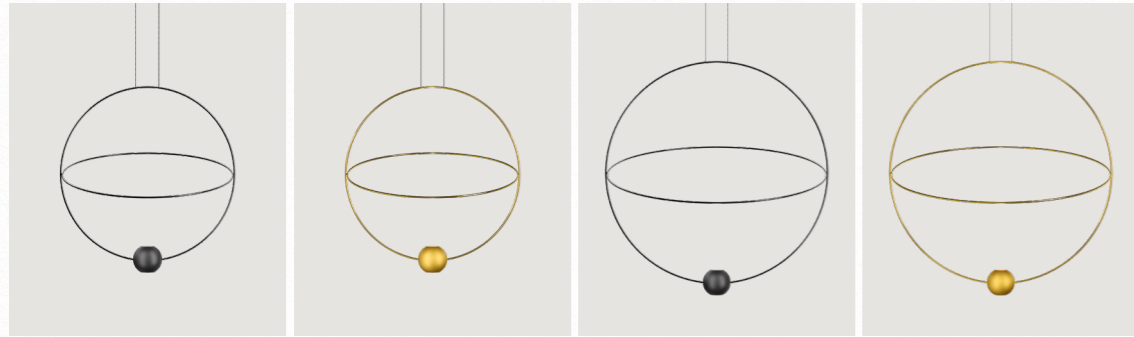

New Concept: *Hover* NEW LAMP

02



New Finish: *Glossy Bronze*

03

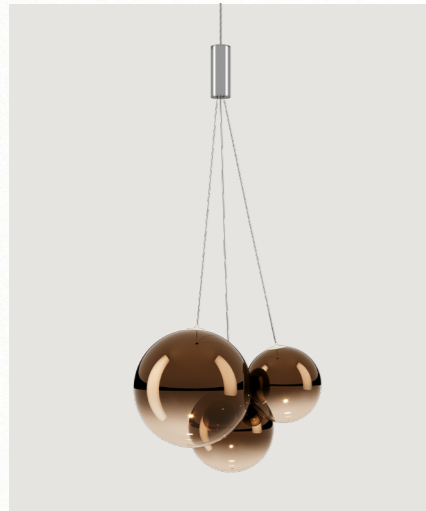

04



2023 Preview

Part 1–New Concept

06–37

01

Elara
design by Nika Zupanc
Suspension lamp

08

02

Hover
design by YOY Studio
Floor lamp, Table lamp

24

Part 2–Finishes

38–52

03

Random
design by Chia–Ying Lee
Cluster suspension lamp

41

04

Random Solo
design by Chia–Ying Lee
Cluster suspension lamp

47

Nika Zupanc



After graduating with honour in 2000 at the *Academy of Fine Arts and Design*, Department of Industrial design in Ljubljana, the Slovenian product and interior designer *Nika Zupanc* became a globally recognised name with the launch of her first object in 2007. In 2008, she established her own eponymous studio in her hometown of Ljubljana and since works as an independent designer constantly involved in projects that grow out of distinctive interpretations of modern culture, contemporary design and available technological options.

Her products are part of the range of distinguished design companies and she works with prestigious clients on specially assigned commitments. Her praised limited edition collections and installations are exhibited around the world, sometimes as part of high-end collaborations like those with *Rossana Orlandi Gallery* in Milano. Along the way, Zupanc continuously produces objects under her own brand *Nika Zupanc* and is involved in various projects and collaborations. Elsewhere, she has continued to build her portfolio to rising acclaim also with curated solo-and-group exhibitions around the world.

In the last few years, Zupanc has become one of the most closely-watched designers at Milan Design Week: not just for her stand-alone products but also for her installations. In 2020 she designed an extensive collection of furniture for Natuzzi Italia and she received the 2020 Archiproducts Design Awards in the Furniture category for the Wave sofa, a central piece to the collection.

Her visual language comes from deep within and is about “communicating the things that cannot be told.”

Dopo essersi laureata con lode nel 2000 presso *Academy of Fine Arts and Design*, in Industrial Design a Lubiana, la product e interior designer slovena *Nika Zupanc* è diventata un nome riconosciuto a livello mondiale con il lancio del suo primo oggetto prodotto su larga scala nel 2007. Nel 2008 ha fondato l'omonimo studio nella sua città natale, Lubiana, e da allora lavora come designer indipendente, costantemente coinvolta in progetti che nascono da interpretazioni distintive della cultura moderna, del design contemporaneo e delle varie tecnologie disponibili.

I suoi prodotti fanno parte del portfolio di rinomati brand di design e collabora con clienti prestigiosi su progetti speciali. Le sue collezioni e installazioni in edizione limitata sono esposte in tutto il mondo, talvolta nell'ambito di collaborazioni di alto livello come quella con la *Galleria Rossana Orlandi* di Milano. Nel frattempo, Zupanc produce continuamente oggetti con il proprio marchio *Nika Zupanc* ed è coinvolta in vari progetti e collaborazioni. Inoltre, ha continuato a costruire il suo portfolio, riscuotendo un crescente successo anche con mostre personali e collettive curate in tutto il mondo.

Negli ultimi anni, Zupanc è diventata una delle designer più seguite durante la Milano Design Week: non solo per i suoi prodotti, ma anche per le sue installazioni. Nel 2020 ha progettato un'ampia collezione di arredi per Natuzzi Italia e ha ricevuto il premio Archiproducts Design Awards 2020 nella categoria Furniture per il divano Wave, pezzo centrale della collezione.

Il suo linguaggio visivo nasce dal profondo e si propone di “comunicare le cose che non possono essere raccontate”.

Product

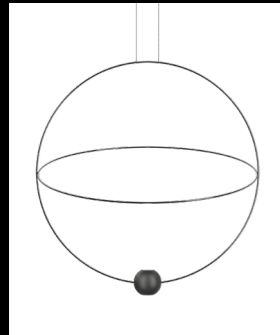

Elara
► Suspension lamp
pag. 08

YOY Studio



Established in 2011, YOY is a design studio by Naoki Ono and Yuki Yamamoto, based in Tokyo and working internationally. They design mainly furniture, lighting and interiors around the theme of “between space and objects”.

YOY specialises in designing products that tell short stories of everyday life, such as “Canvas”, a canvas with a drawing of a chair, which doubles as a chair by leaning against a wall, and “Scribble”, a series of table mats that look like scribbles. The products pursue aspects of design that go beyond ease of use and functionality.

YOY first presented their independent works at Milan Design Week 2012 and have since participated in the event for eight consecutive years. Their works have now been commercialized by European and American brands.

They have held exhibitions including “Fictionality”, which featured works that infuse fiction into everyday life, and “Existence”, which focused on themes of human nature, perception and existence.

Their works are sold all over the world including MoMA, and they have received several international awards.

Fondato nel 2011 da Naoki Ono e Yuki Yamamoto, YOY è uno studio di design con sede a Tokyo e operante a livello internazionale. Il tema centrale che caratterizza il loro design, è l'analisi del rapporto “tra spazio e oggetto” nel progettare arredi, illuminazione e spazi interni.

YOY è specializzato nella progettazione di prodotti che raccontano brevi storie di vita quotidiana, come “Canvas”, una tela con il disegno di una sedia, che si trasforma in una sedia appoggiata al muro, e “Scribble”, una serie di tovagliette che sembrano scarabocchi. I prodotti perseguono aspetti del design che vanno oltre la facilità d'uso e la funzionalità.

Gli YOY hanno presentato per la prima volta i loro lavori indipendenti alla Milano Design Week del 2012 e da allora hanno partecipato all'evento per otto anni consecutivi. I loro lavori sono stati messi in vendita da brand europei e americani.

Hanno organizzato mostre come “Fictionality”, che presentava opere che infondono finzione nella vita quotidiana, e “Existence”, incentrata sui temi legati alla natura umana, alla percezione e all'esistenza.

I loro lavori sono venduti in tutto il mondo, incluso il MoMA, e hanno ricevuto numerosi premi internazionali.

Products



Hover
► Floor lamp
pag. 24



Hover
► Table lamp
pag. 24

New Concept: Elara

Part 1-New Concept: Elara medium

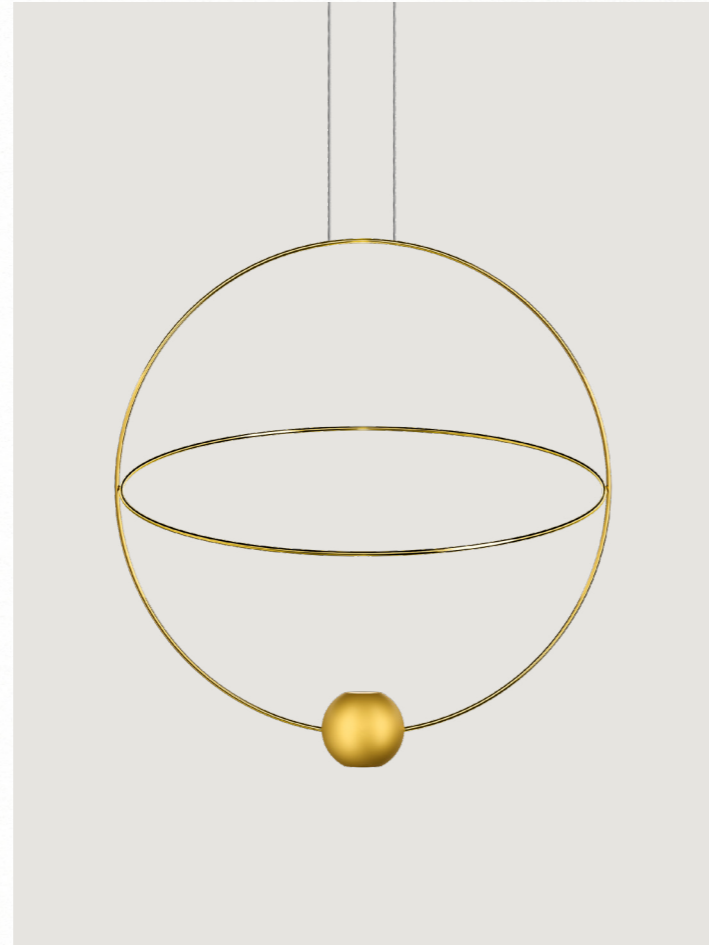
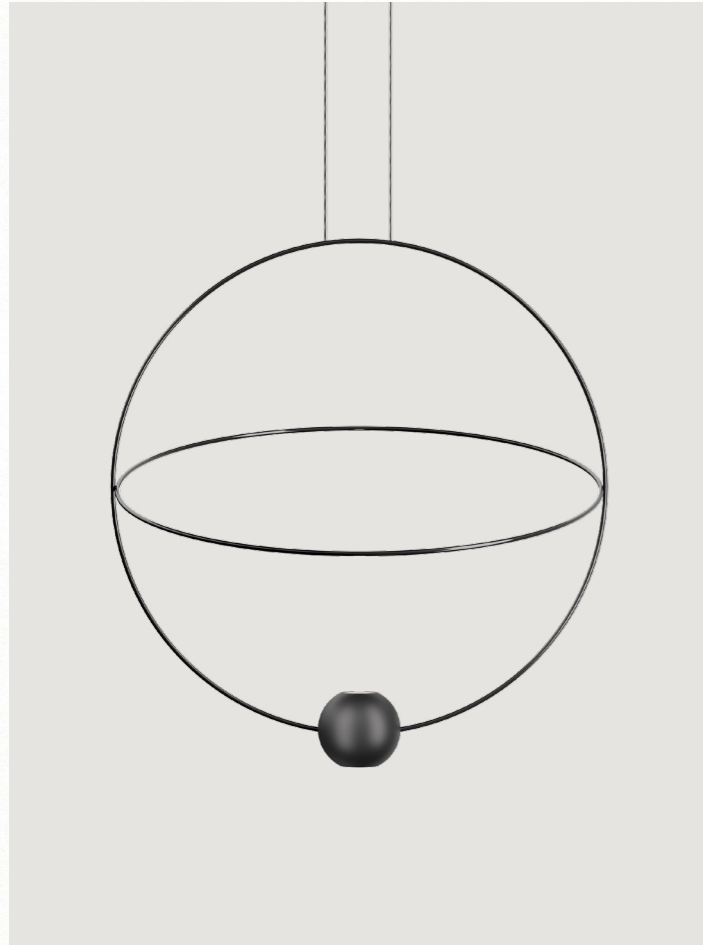

● Black

○ Gold

Elara large

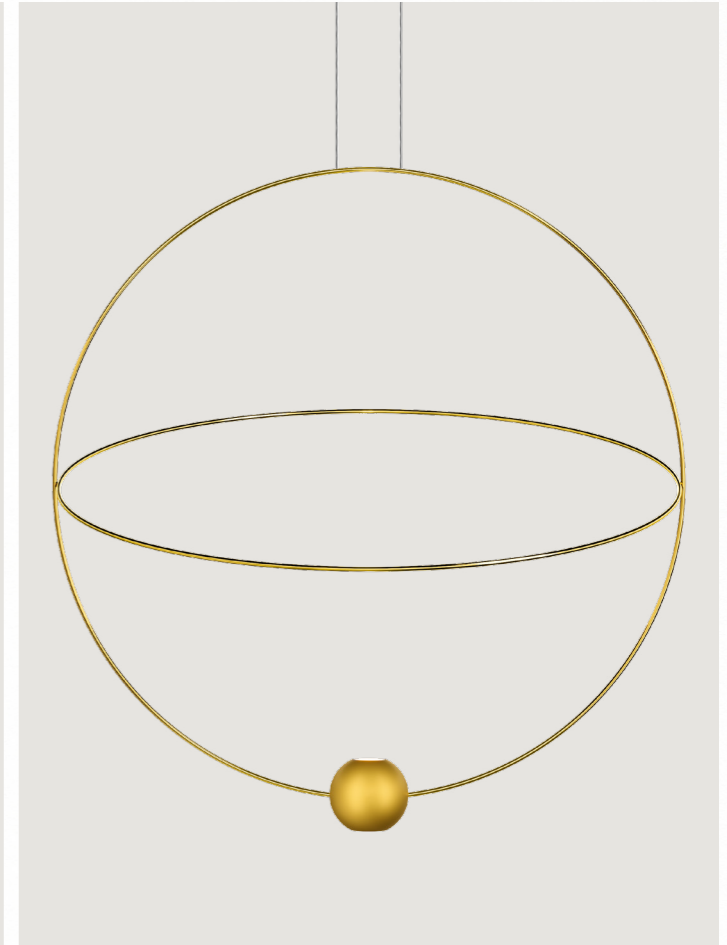
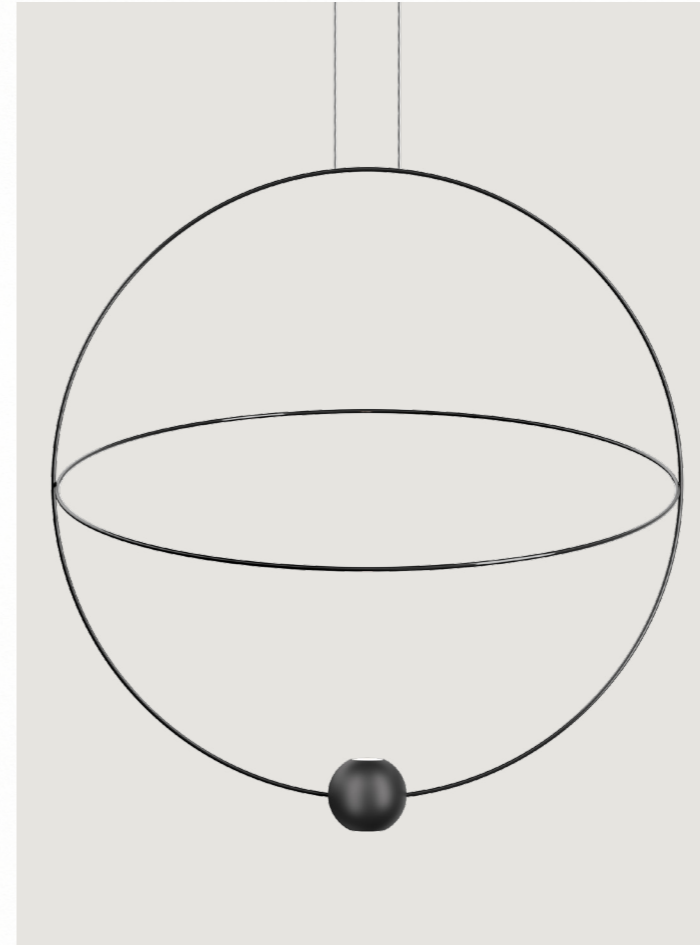

● Black

○ Gold

Elara

The name Elara connotes astronomy and Greek mythology, and its geometric design mimicks the trajectory of the planets within the universe. Inspired by astral motion, the lamp is characterised by two metal rings, one of which can be set at various angles to produce fluidity and movement, as well as a small sphere at the bottom of the lamp that contains the light source.

The central ring can be positioned to reach different heights and angles, allowing users to experiment with casting light and shadows. Elara features a dimmer controlled with the wall-mounted power switch, allowing users to modulate the intensity of the light to create their ideal lighting scheme.

Available in two sizes, medium (Ø 60 cm) and large (Ø 80 cm), Elara suits a range of environments, such as over a dining table in a residential setting, or as part of a larger installation in public spaces like a hotel lounge or restaurant.

Il nome Elara richiama l'astronomia e la mitologia greca, e il suo design geometrico imita la traiettoria dei pianeti nell'universo. Ispirata al movimento astrale, la lampada è caratterizzata da due anelli metallici, uno dei quali può essere posizionato a varie angolazioni per produrre fluidità e movimento, e da una piccola sfera all'estremità inferiore della lampada che contiene la sorgente luminosa. L'anello centrale può essere posizionato in modo da raggiungere diverse altezze e angolazioni, consentendo agli utenti di sperimentare la proiezione di luci e ombre. Inoltre, Elara è dimmerabile mediante dimmer comandato dall'interruttore a parete, che consente di modulare l'intensità della luce per creare il proprio schema di illuminazione ideale.

Disponibile in due dimensioni, medium (Ø 60 cm) e large (Ø 80 cm), Elara si adatta ad una vasta gamma di ambienti, come ad esempio sopra un tavolo da pranzo in un ambiente residenziale, o come parte di un'installazione più grande in spazi pubblici come la lounge di un hotel o un ristorante.

Suspension lamp

Elara medium and large,
FINISHES Black and Gold

Elara, design by Nika Zupanc, 2022





Elara medium and large,
FINISHES Black and Gold



Elara, metal rings, FINISH Glossy Black

Elara large, FINISH Black

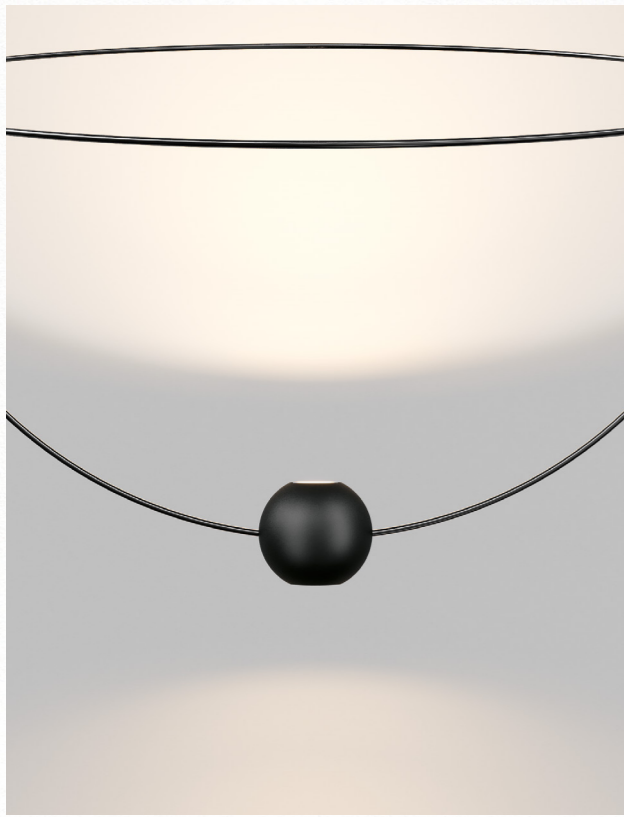

1

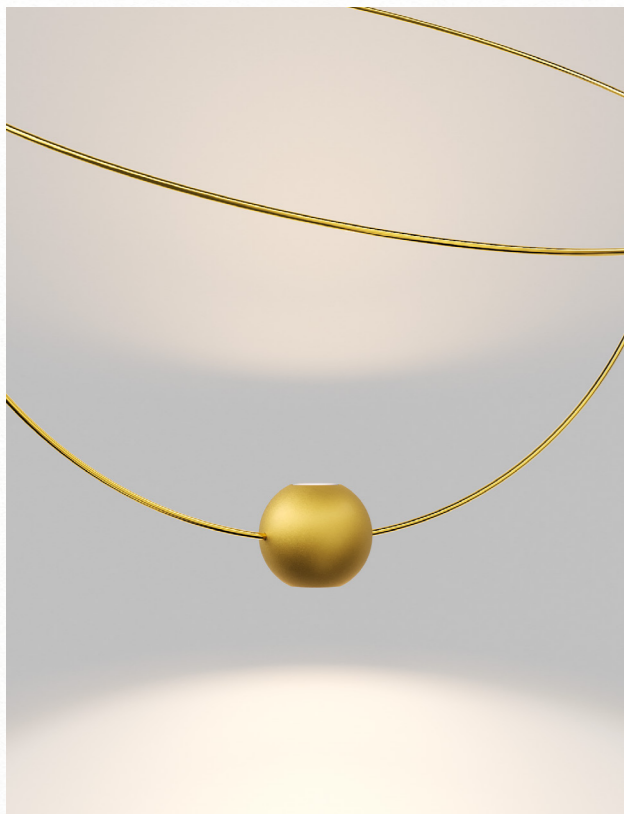

2

1–Metal sphere, side I (up)
side II (down), FINISH Extra Matte Black
2–Metal sphere, side I (down)
side II (up), FINISH Matte Gold

Elara large, FINISH Black





Elara medium, FINISH Gold



Elara large, FINISH Gold



Elara is characterised by two metal rings, one of which can be set at various angles

Le nom Elara évoque l'astronomie et la mythologie grecque, et son design géométrique la trajectoire des planètes dans l'univers. S'inspirant du mouvement astral, la lampe se caractérise par deux anneaux métalliques : un pouvant être positionné à différents angles, créant ainsi fluidité et mouvement, et par une petite sphère à l'extrémité inférieure de la lampe qui abrite la source lumineuse. L'anneau central peut être positionné pour atteindre différents angles et hauteurs, permettant aux utilisateurs d'expérimenter la projection de lumière et d'ombre. De plus, Elara est dimmable au moyen d'un gradateur contrôlé par l'interrupteur mural qui permet de moduler l'intensité de la lumière pour créer un éclairage idéal. Disponible en deux tailles, medium (Ø 60 cm) et large (Ø 80 cm), Elara s'adapte à une vaste gamme d'environnements, par exemple suspendue au-dessus d'une table dans une habitation, ou comme élément d'un agencement plus important tel qu'un hall d'hôtel ou un restaurant. ● FR

Der Name Elara erinnert an die Astronomie und die griechische Mythologie, und so ahmt das geometrische Design der Leuchte die Flugbahn der Planeten im Universum nach. Inspiriert von diesen astralen Bewegungen besteht die Leuchte aus zwei Metallringen, von denen einer in verschiedenen Winkeln positioniert werden kann, um eine fließende Bewegung zu erzeugen, sowie aus einer kleinen Kugel am unteren Ende der Leuchte, welche die Lichtquelle enthält. Der zentrale, horizontale Ring kann in verschiedenen Höhen und Winkeln positioniert werden, so dass die Benutzenden mit der Projektion von Licht und Schatten experimentieren können. Darüber hinaus ist Elara über einen an der Wand angebrachten Dimmer stufenlos regelbar, so dass die Lichtintensität je nach Bedarf angepasst werden kann, um individuellen Beleuchtungskonzepten gerecht zu werden. Erhältlich in zwei Größen, Medium (Ø 60 cm) und Large (Ø 80 cm), eignet sich Elara für eine Vielzahl von Umgebungen, wie z. B. über einem Esstisch im Wohnbereich oder als Teil einer größeren Installation in öffentlichen Räumen, wie einer Hotel-Lounge oder einem Restaurant. ● DE

Elara medium ↘ Suspension lamp **NEW LAMP**

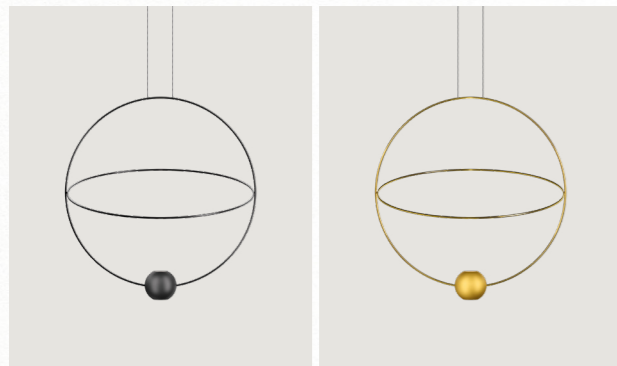

Elara large ↘ Suspension lamp **NEW LAMP**

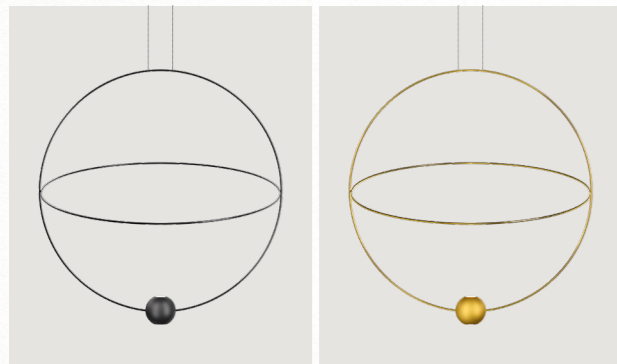

El nombre Elara evoca la astronomía y la mitología griega y su diseño geométrico imita la trayectoria de los planetas en el universo. Inspirada en el movimiento astral, la lámpara se caracteriza por dos anillos metálicos, uno de los cuales se puede colocar en distintos ángulos para crear fluidez y movimiento, y una pequeña esfera en el extremo inferior de la lámpara que contiene la fuente luminosa. El anillo central se puede colocar de forma que alcance distintas alturas y ángulos y permite a los usuarios experimentar la proyección de luces y sombras. Además Elara puede ajustarse con un regulador que controla el interruptor de pared y permite modular la intensidad de la luz para crear un esquema de iluminación ideal propio. Disponible en dos tamaños, medium (mediano) (Ø 60 cm) y large (grande) (Ø 80 cm), Elara se adapta a una amplia gama de ambientes, como por ejemplo encima de una mesa de comedor en un entorno residencial, o como parte de una instalación más grande en espacios públicos como el salón de un hotel o un restaurante. ● ES

Название Elara напоминает нам об астрономии и греческой мифологии, ее геометрический дизайн имитирует траектории движения планет во вселенной. Лампа, вдохновленная движением звезд, имеет два металлических кольца, одно из которых может устанавливаться под разными углами, создавая текучесть и мобильность, и небольшую сферу на нижней стороне лампы, содержащей внутри источник освещения. Центральное кольцо можно располагать на различной высоте и под разными углами, что позволяет пользователям экспериментировать с проекцией света и тени. Дополнительно к этому, Elara может регулироваться с помощью диммера, управляемого настенным выключателем, позволяющего регулировать интенсивность света и создавать собственную идеальную схему освещения. Elara выпускается двух размеров, средний (Ø 60 см) и большой (Ø 80 см), и адаптируется к самым разнообразным помещениям, она может быть подвешена над

обеденным столом в жилом помещении или может стать частью более крупной инсталляции в общественных пространствах, таких как холл отеля или ресторан. ● RU

Elara一名呼应天文学和希腊神话,同时它的几何设计还仿照宇宙中的行星运行轨迹。受星体运动的启发,两只金属圆环是这款灯的特色所在,其中一只能够以不同角度定位,从而产生流动性和运动性,并使灯体下端形成一个容纳光源的小球体。中心圆环通过定位可达到不同高度和角度,允许用户尝试光与影的投射。此外,Elara可通过由壁式开关控制的调光器进行调光,使您能够在调整光线强度后营造理想的照明解决方案。Elara提供medium中号(Ø 60厘米)和large大号(Ø 80厘米)两种尺寸,适用于各种环境,例如居家环境中的餐桌上方或是在酒店休息室和餐厅等公共空间中作为大型装置的组成部分。● ZH

Elara, design by Nika Zupanc, 2022

Suspension lamp

Elara medium

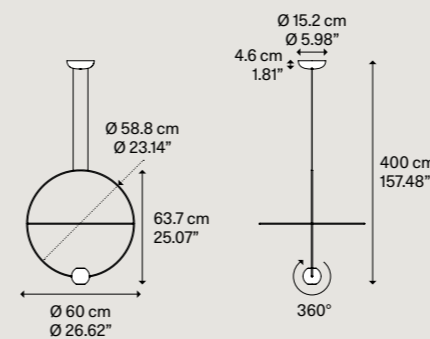

Net weight/Peso netto: 1.9 kg

Pack/Colli: 1

Light source Sorgente luminosa

LED
↘ 2700 K
↘ 27 W
Side I 2100 lm
Side II 800 lm
↘ 1000 mA
↘ CRI 90
↘ MacAdam 3-Step

or

LED
↘ 3000 K
↘ 27 W
Side I 2260 lm
Side II 845 lm
↘ 1000 mA
↘ CRI 90
↘ MacAdam 3-Step

LED and driver included
LED e driver inclusi

Metal structure Montatura in metallo

● Glossy Black
Nero Lucido

● Glossy Gold
Oro Lucido

● Glossy Black
Nero Lucido

● Glossy Gold
Oro Lucido

Metal sphere Sfera in metallo

● Extra Matte Black
Nero Extra Opaco

● Matte Gold
Oro Opaco

● Extra Matte Black
Nero Extra Opaco

● Matte Gold
Oro Opaco

Code Codice

20621 2227

20621 5027

20621 2230

20621 5030

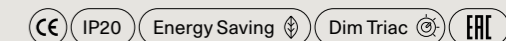

Elara large

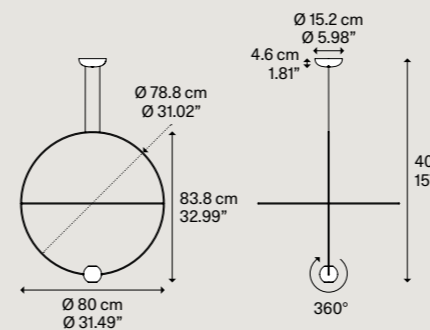

Net weight/Peso netto: 2 kg

Pack/Colli: 1

Light source Sorgente luminosa

LED
↘ 2700 K
↘ 27 W
Side I 2100 lm
Side II 800 lm
↘ 1000 mA
↘ CRI 90
↘ MacAdam 3-Step

or

LED
↘ 3000 K
↘ 27 W
Side I 2260 lm
Side II 845 lm
↘ 1000 mA
↘ CRI 90
↘ MacAdam 3-Step

LED and driver included
LED e driver inclusi

Metal structure Montatura in metallo

● Glossy Black
Nero Lucido

● Glossy Gold
Oro Lucido

● Glossy Black
Nero Lucido

● Glossy Gold
Oro Lucido

Metal sphere Sfera in metallo

● Extra Matte Black
Nero Extra Opaco

● Matte Gold
Oro Opaco

● Extra Matte Black
Nero Extra Opaco

● Matte Gold
Oro Opaco

Code Codice

20622 2227

20622 5027

20622 2230

20622 5030

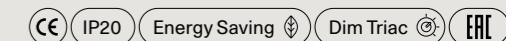

Adjustable light Luce orientabile

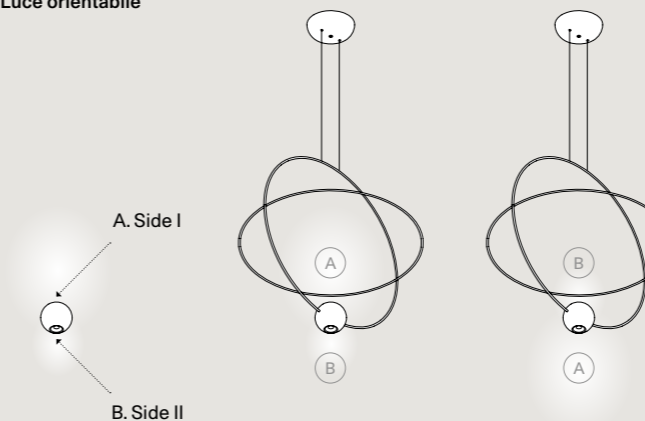

Adjustable ring Anello orientabile

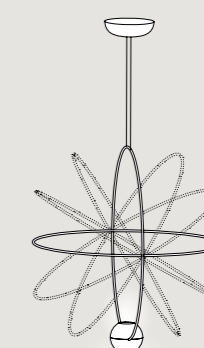

New Concept: Hover

Part 1 - New Concept: Hover

Floor lamp



○ Matte White

Table lamp



○ Matte White

Hover

The Hover table and floor lamps feature a lamp shade that looks as if it is detached from the base, connected seamlessly by a single cable that runs through the stem and comes out of the other end. The end result creates an illusion that the light source is almost weightless and floating in the air, like a balloon. Hover features a dimmer controlled by a power switch on the upper end of the stem; users can simply touch the top of the stem to modulate the intensity of the light. All typically external technical functions have been carefully incorporated within the lamp's internal structure. Additionally, the power supply comes in the form of a USB cable.

Available as a table or floor lamp, Hover suits different uses such as on a desk, side table or next to a sofa. The floor lamp could also be used for public spaces including an airport lounge, a hotel room or lobby.

Le lampade da tavolo e da terra Hover presentano un paralume che sembra separato dalla base, collegato perfettamente da un unico cavo che attraversa lo stelo per poi uscirne. Il risultato finale crea l'illusione che la sorgente luminosa sia quasi priva di peso e fluttui nell'aria, come un palloncino.

Hover è dotata di un dimmer controllato da un interruttore di alimentazione posto all'estremità superiore dello stelo; gli utenti possono semplicemente toccare la parte superiore dello stelo per modulare l'intensità della luce. Tutte le funzioni tecniche tipicamente esterne sono state accuratamente incorporate nella struttura interna della lampada. Inoltre, l'alimentazione è fornita grazie ad un cavo USB.

Disponibile come lampada da tavolo o da terra, Hover si adatta a diversi usi, come ad esempio su una scrivania, un tavolino o accanto ad un divano. La versione da terra può essere utilizzata anche in spazi pubblici come in una lounge di un aeroporto, in una camera di un hotel o una hall.

Floor lamp, Table lamp

Hover table and floor,
FINISH Matte White

Hover, *design by YOY Studio, 2022*





Hover table and floor, FINISH Matte White



Hover, USB socket

Hover table, FINISH Matte White

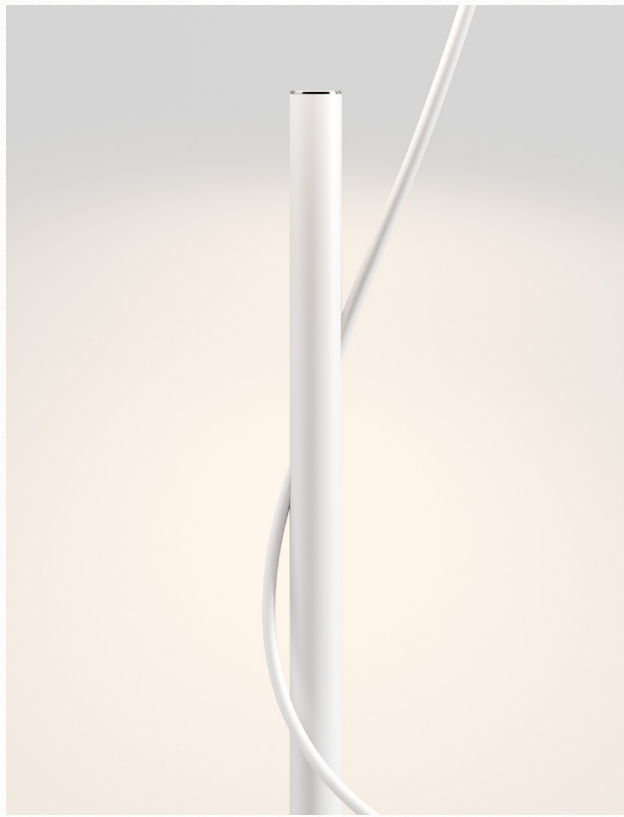

1



2

1–Hover, the lamp shade is connected seamlessly by a single cable that runs through the stem and comes out of the other end

2–Hover, switch on and off and dim the light intensity

Hover floor, FINISH Matte White





Hover table,
FINISH Matte White



1

1-Hover, the shade comprises a sheet made from a special compound of paper and polymer film



Hover table, FINISH Matte White

Hover floor and table,
FINISH Matte White



L'abat-jour des lampes de table et des lampadaires Hover semble séparé de la base et parfaitement relié par un câble unique qui traverse entièrement la tige. Le résultat final crée l'illusion d'une source lumineuse qui flotte dans l'air quasiment en apesanteur, comme un ballon. Hover est équipé d'un gradateur commandé par un interrupteur d'alimentation situé à l'extrémité supérieure de la tige ; les utilisateurs n'ont qu'à toucher le haut de la tige pour moduler l'intensité de la lumière. Toutes les fonctions techniques habituellement externes ont été soigneusement intégrées dans la structure interne de la lampe. En outre, l'alimentation est fournie via un câble USB. Disponible en lampe de table ou en lampadaire, Hover convient à différents usages, comme lampe de bureau, de table basse ou à côté d'un canapé. La version au sol peut également être installée dans des espaces publics tels qu'un lounge d'aéroport, une chambre d'hôtel ou un hall. ● FR

Die Tisch- und Stehleuchten Hover verfügen über einen Leuchtschirm, der vom Sockel getrennt zu sein scheint, verbunden auf perfekte Weise durch ein einziges Kabel, das durch den Schaft hindurch und aus ihm herausführt. Das Endergebnis erzeugt die Illusion, dass die Lichtquelle fast schwerelos ist und wie ein Ballon in der Luft schwebt. Hover ist mit einem Dimmer ausgestattet, der über einen Schalter am oberen Ende des Schaftes reguliert wird; die Benutzer können die Lichtintensität durch einfaches Berühren des oberen Endes des Schaftes einstellen. Alle typischen externen technischen Funktionen wurden sorgfältig in die innere Struktur der Leuchte integriert. Außerdem erfolgt die Stromversorgung über ein USB-Kabel. Erhältlich als Tisch- oder Stehleuchte, eignet sich Hover für verschiedene Verwendungszwecke, z. B. auf einem Schreibtisch, einem Beistelltisch oder neben einem Sofa. Die Bodenversion kann auch in öffentlichen Räumen wie einer Flughafenlounge, einem Hotelzimmer oder einer Empfangshalle eingesetzt werden. ● DE

Las lámparas de sobremesa y de pie Hover poseen una pantalla que parece separada de la base, conectada perfectamente por un solo cable que atraviesa la barra y luego sale. El resultado final da la sensación de que la fuente luminosa prácticamente no pesa y flota en el aire, como un globo. Hover está equipada con un regulador que controla un interruptor de alimentación situado en el extremo superior de la barra; los usuarios, simplemente tocando la parte superior de la barra, pueden regular la intensidad de la luz. Todas las funciones técnicas que normalmente están fuera se han incorporado minuciosamente en la estructura interna de la lámpara. Además, la alimentación se suministra gracias a un cable USB. Hover, disponible como lámpara de sobremesa o de pie, se adapta a distintos usos, como por ejemplo en un escritorio, una mesita o junto a un sofá. La versión de pie también se puede utilizar en espacios públicos como en la sala de un aeropuerto, una habitación de hotel o un vestíbulo. ● ES

Настольные лампы и торшеры Hover имеют абажур, который кажется отделенным от основания и соединенным одним кабелем, пересекающим стержень, а затем выходящим наружу. В результате возникает иллюзия невесомости источника света, парящего в воздухе, как воздушный шар. Hover оснащен диммером, управляемым выключателем, расположенным на верхнем конце стержня; пользователи могут отрегулировать интенсивность света, просто прикоснувшись к верхней части стержня. Все технические функции, обычно находящиеся снаружи, были встроены во внутреннюю структуру светильника. Питание также подается по кабелю USB. Hover выпускается в виде настольной лампы или торшера, и подходит для различного применения, на письменном столе, журнальном столике или рядом с диваном. Напольный вариант может также устанавливаться в общественных зданиях, например в зале аэропорта, в гостиничном номере или в холле. ● RU

Hover的台灯款和落地灯款均带有一个看似与底座分开的灯罩，但灯罩与底座之间却由一根从灯罩部位穿插而过的单根线缆完美连接。最终结果营造一种幻觉，光源仿佛几乎没有重量且会像气球一般漂浮于空中。Hover配有一部由位于灯罩上端的电源开关控制的调光器；用户只需轻触灯罩顶部便可调节光的强度。所有典型的外部技术功能均已巧妙整合至灯件的内部结构之中。此外，电源供给是通过一根USB线缆完成的。Hover提供台灯或落地灯两个版本，适用于不同用途，例如放在书桌、咖啡桌上或沙发近旁。落地灯版本也可用于机场休息室、酒店房间或大堂等公共场所。● ZH

Hover ▾ Floor lamp, Table lamp **NEW LAMP**

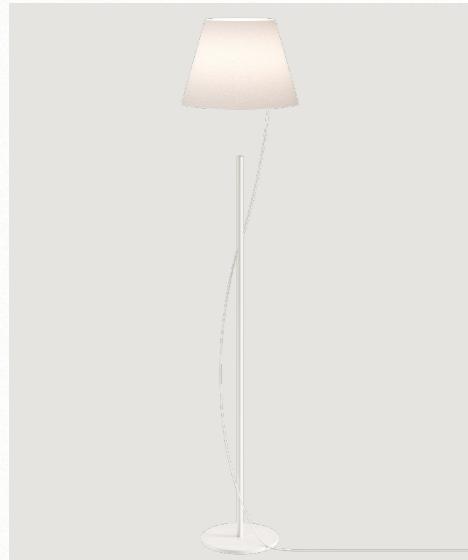

Hover, design by YOY Studio, 2022

Floor lamp

Hover

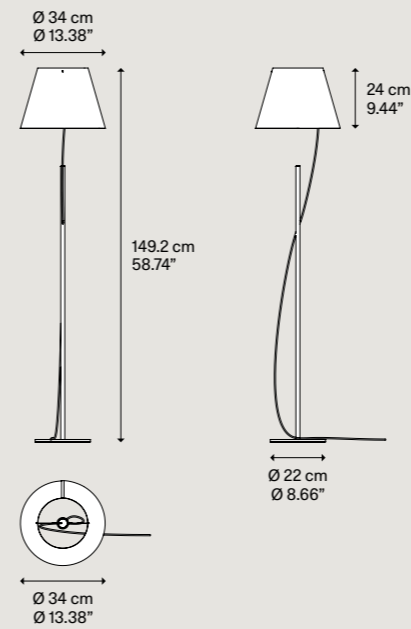

Net weight / Peso netto: 6 kg

Pack / Colli: 1

Light source
Sorgente luminosa

LED
 ▾ 2700 K
 ▾ 6 W / 1000 lm
 ▾ 5V 2A
 ▾ CRI 90
 ▾ MacAdam 3-Step

LED and driver included
LED e driver inclusi

Metal structure
Montatura in metallo

● Matte White
Bianco Opaco

Paper diffuser
Diffusore in carta

● Matte White
Bianco Opaco

Code
Codice

18471 1027



Table lamp

Hover

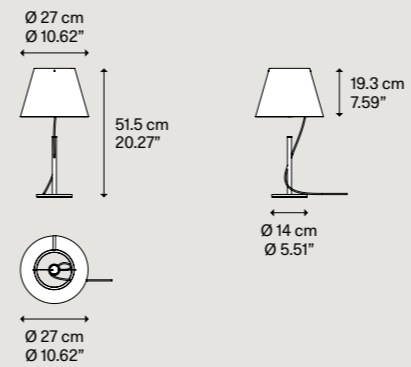

Net weight / Peso netto: 2.2 kg

Pack / Colli: 1

Light source
Sorgente luminosa

LED
 ▾ 2700 K
 ▾ 6 W / 1000 lm
 ▾ 5V 2A
 ▾ CRI 90
 ▾ MacAdam 3-Step

LED and driver included
LED e driver inclusi

Metal structure
Montatura in metallo

● Matte White
Bianco Opaco

Paper diffuser
Diffusore in carta

● Matte White
Bianco Opaco

Code
Codice

18480 1027

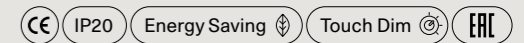

Touch dimmer



Finishes

New Finish: *Glossy Bronze*

● Glossy Bronze/Bronzo Lucido

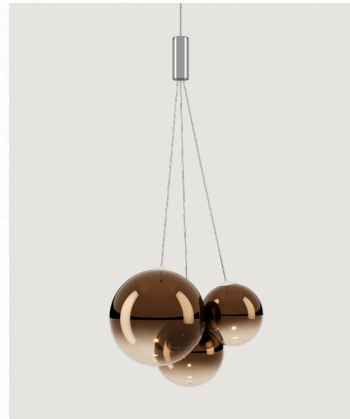

Random

● Glossy Bronze/Bronzo Lucido

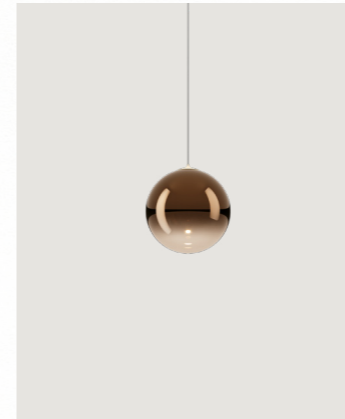

Random Solo 12

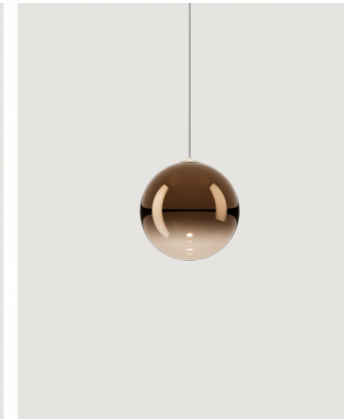

Random Solo 14

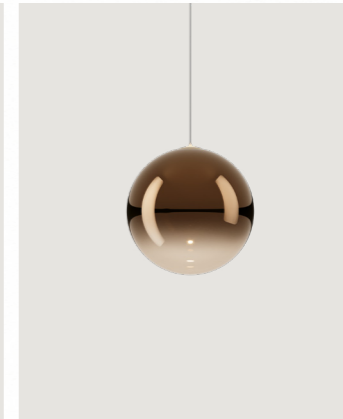

Random Solo 18

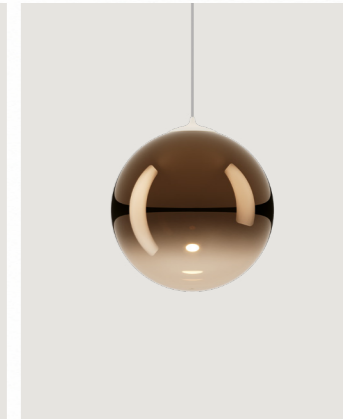

Random Solo 23

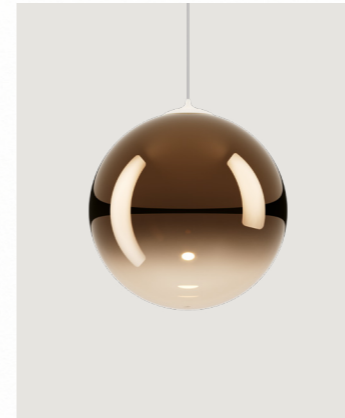

Random Solo 28

New Finish: GLOSSY BRONZE

As brilliant as the creative touch it bestows on the environment, *Glossy Bronze* is synonymous with alluring beauty. *Random* and *Random Solo* are now available in this warm and earthy colour that inspires stability and sturdiness and infuses calmness to any living environments. Its materic nature warms the ambience with a few simple touches and creates a distinctly homely atmosphere.

Brillante come il tocco creativo che infonde all'ambiente, *Glossy Bronze* è sinonimo di bellezza affascinante. *Random* e *Random Solo* sono ora disponibili in questa finitura calda e terrosa, che ispira stabilità e robustezza e infonde calma a qualsiasi ambiente abitativo. La sua matericità scalda l'ambiente con pochi semplici tocchi e crea un'atmosfera decisamente confortevole.

Random

↳ Cluster suspension lamp
p. 41

- Clear
- Frosted White
- Chrome
- Glossy Smoke
- Glossy Bronze NEW
- Gold
- Rose Gold

Random Solo

↳ Cluster suspension lamp
p. 47

- Clear
- Frosted White
- Chrome
- Glossy Smoke
- Glossy Bronze NEW
- Gold
- Rose Gold

Random, design by Chia-Ying Lee, 2017

Spec sheet p. 54



Random, FINISHES Glossy
Smoke and Glossy Bronze



Random, composition of 7 lights on a *rectangular canopy*, FINISHES Glossy Bronze and Chrome

Random, *recessed micro canopy*, FINISHES Glossy Bronze and Chrome



New Glossy Finish



Random, FINISH Glossy Bronze

Random, *recessed micro canopy*,
FINISHES Glossy Bronze and Clear

Aussi brillant que la touche créative qu'il diffuse dans l'environnement, *Glossy Bronze* est une source de beauté irrésistible. *Random* et *Random Solo* sont désormais disponibles dans cette finition chatoyante et terreuse qui évoque stabilité, force et tranquillité dans tous les styles d'habitation. Quelques touches de ce caractère matérielle suffisent pour octroyer à l'espace une chaleur et une atmosphère résolument confortables. ● FR

So brillant wie der kreative Touch, den es dem Raum verleiht, ist *Glossy Bronze* ein Synonym für faszinierende Schönheit. *Random* und *Random Solo* sind jetzt in dieser warmen, erdigen Ausführung erhältlich, die Stabilität und Robustheit ausstrahlt und in jeder Wohnumgebung eine gewisse Ruhe verbreitet. Seine Materialität wärmt das Ambiente mit wenigen einfachen Berührungen und schafft eine ausgesprochen wohnliche Atmosphäre. ● DE

Brillante como el toque creativo que infunde al ambiente, *Glossy Bronze* es sinónimo de belleza deslumbrante. Ahora *Random* y *Random Solo* están disponibles en este acabado cálido y terroso que inspira estabilidad y solidez e infunde calma a cualquier ambiente residencial. Su materialidad da calidez al ambiente con tan solo unos simples toques y crea sin duda una atmósfera comfortable. ● ES

Блестящий, как и творческий штрих, передающийся всему помещению, *Glossy Bronze* является синонимом чарующей красоты. Теперь *Random* и *Random Solo* выпускаются с теплой и естественной отделкой, внушающей ощущение стабильности и надежности и приносящей спокойствие в любое жилище. Ее материалность согревает помещение своим прикосновением и создает ощутимую атмосферу уюта. ● RU

光彩照人，就如一丝倾入环境的创意润饰，亮光铜色是迷人之美的代名词。*Random*和*Random Solo*现下提供这款温暖而朴实的饰面，激发稳定性和坚固性并为任何居住环境注入平和安宁。它的实质性，通过一些简约润饰为环境升温并营造出一片绝对舒适的氛围。● ZH

Random Solo, design by Chia-Ying Lee, 2020



Random Solo, FINISHES Glossy Bronze and Clear



Random Solo, composition of 9 lights on a *round canopy*, FINISHES Glossy Bronze, Glossy Smoke and Clear

Random Solo, *recessed micro canopy*, FINISHES Glossy Bronze, Glossy Smoke and Clear



Random Solo, composition of 14 lights on a round canopy, FINISHES Glossy Bronze and Clear



Random Solo, FINISH Glossy Bronze

Spec sheet

Random 54
design by Chia-Ying Lee
Cluster suspension lamp

Random Solo 55
design by Chia-Ying Lee
Cluster suspension lamp

Random, design by Chia-Ying Lee, 2017

Cluster suspension lamp

Random

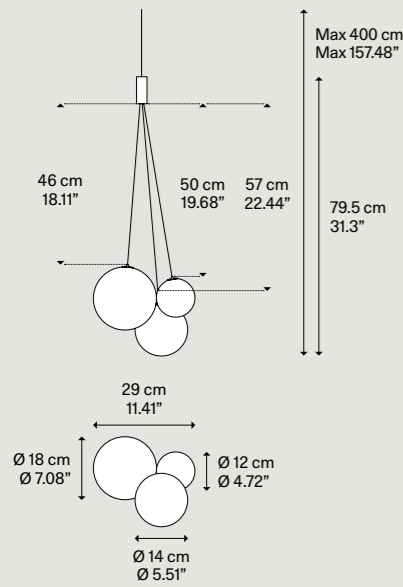

Light source Sorgente luminosa	Metal structure Montatura in metallo	Blown glass diffuser Diffusore in vetro soffiato	Code Codice
LED ↘ 2700 K ↘ 3 × 1 W/450 lm ↘ 350 mA ↘ CRI 90 ↘ MacAdam 3-Step LED and driver included LED e driver inclusi	Chrome Cromo	Clear Trasparente	16420 0027
		Frosted White Bianco Satinato	16420 1327
		Chrome Cromo	16420 4027
		Glossy Smoke Fumo Lucido	16420 4327
		Glossy Bronze ^{NEW} Bronzo Lucido	16420 4627
		Gold Oro	16420 5027
		Rose Gold Oro Rosa	16420 5527
		Clear Trasparente	16420 0030
		Frosted White Bianco Satinato	16420 1330
		Chrome Cromo	16420 4030
LED ↘ 3000 K ↘ 3 × 1 W/480 lm ↘ 350 mA ↘ CRI 90 ↘ MacAdam 3-Step LED and driver included LED e driver inclusi	Chrome Cromo	Glossy Smoke Fumo Lucido	16420 4330
		Glossy Bronze ^{NEW} Bronzo Lucido	16420 4630
		Gold Oro	16420 5030
		Rose Gold Oro Rosa	16420 5530
		Clear Trasparente	16420 0030

Net weight/Peso netto: 1.0 kg

Pack/Colli: 2

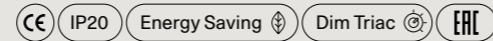

Suspension lamps must be installed on a canopy.

Random Solo, design by Chia-Ying Lee, 2020

Cluster suspension lamp

Random Solo 12

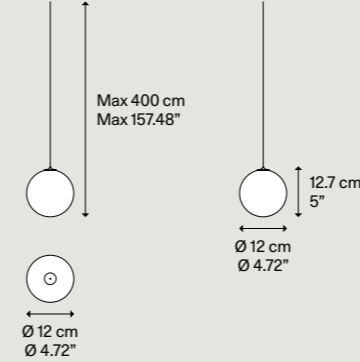

Light source Sorgente luminosa	Blown glass diffuser Diffusore in vetro soffiato	Code Codice
LED ↘ 2700 K ↘ 1 W/150 lm ↘ 350 mA ↘ CRI 90 ↘ MacAdam 3-Step LED and driver included LED e driver inclusi	Clear Trasparente	17111 0027
	Frosted White Bianco Satinato	17111 1327
	Chrome Cromo	17111 4027
	Glossy Smoke Fumo Lucido	17111 4327
	Glossy Bronze ^{NEW} Bronzo Lucido	17111 4627
	Gold Oro	17111 5027
	Rose Gold Oro Rosa	17111 5527
	Clear Trasparente	17111 0030
	Frosted White Bianco Satinato	17111 1330
	Chrome Cromo	17111 4030
LED ↘ 3000 K ↘ 1 W/160 lm ↘ 350 mA ↘ CRI 90 ↘ MacAdam 3-Step LED and driver included LED e driver inclusi	Glossy Smoke Fumo Lucido	17111 4330
	Glossy Bronze ^{NEW} Bronzo Lucido	17111 4630
	Gold Oro	17111 5030
	Rose Gold Oro Rosa	17111 5530
	Clear Trasparente	17111 0030

Net weight/Peso netto: 0.25 kg

Pack/Colli: 2

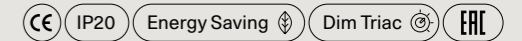

Suspension lamps must be installed on a canopy. Not suitable for the Radial System.

Le lampade a sospensione devono essere installate su rosone. Non utilizzabile sul Sistema Radiale.

Random Solo, design by Chia-Ying Lee, 2020

Cluster suspension lamp

Random Solo 14

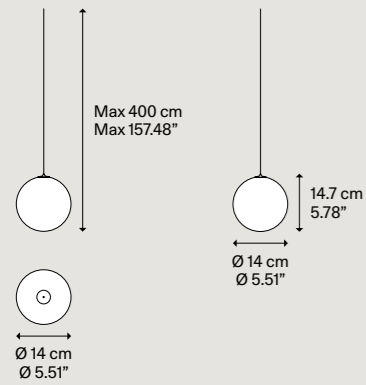

Light source Sorgente luminosa	Blown glass diffuser Diffusore in vetro soffiato	Code Codice
LED ↘ 2700 K ↘ 1 W/150 lm ↘ 350 mA ↘ CRI 90 ↘ MacAdam 3-Step LED and driver included LED e driver inclusi	Clear Trasparente	17112 0027
	Frosted White Bianco Satinato	17112 1327
	Chrome Cromo	17112 4027
	Glossy Smoke Fumo Lucido	17112 4327
	Glossy Bronze ^{NEW} Bronzo Lucido	17112 4627
	Gold Oro	17112 5027
	Rose Gold Oro Rosa	17112 5527
	Clear Trasparente	17112 0030
	Frosted White Bianco Satinato	17112 1330
	Chrome Cromo	17112 4030
LED ↘ 3000 K ↘ 1 W/160 lm ↘ 350 mA ↘ CRI 90 ↘ MacAdam 3-Step LED and driver included LED e driver inclusi	Glossy Smoke Fumo Lucido	17112 4330
	Glossy Bronze ^{NEW} Bronzo Lucido	17112 4630
	Gold Oro	17112 5030
	Rose Gold Oro Rosa	17112 5530
	Clear Trasparente	17112 0030

Net weight/Peso netto: 0.32 kg

Pack/Coll: 2

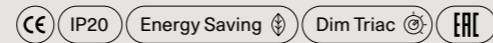

Random Solo, design by Chia-Ying Lee, 2020

Cluster suspension lamp

Random Solo 18

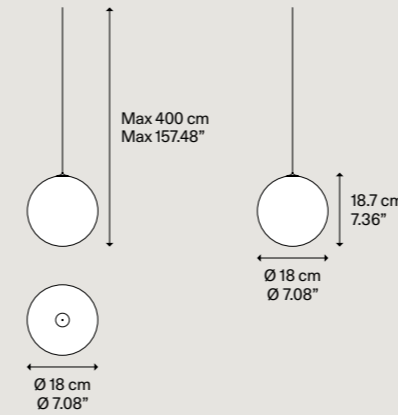

Light source Sorgente luminosa	Blown glass diffuser Diffusore in vetro soffiato	Code Codice
LED ↘ 2700 K ↘ 1 W/150 lm ↘ 350 mA ↘ CRI 90 ↘ MacAdam 3-Step LED and driver included LED e driver inclusi	Clear Trasparente	17113 0027
	Frosted White Bianco Satinato	17113 1327
	Chrome Cromo	17113 4027
	Glossy Smoke Fumo Lucido	17113 4327
	Glossy Bronze ^{NEW} Bronzo Lucido	17113 4627
	Gold Oro	17113 5027
	Rose Gold Oro Rosa	17113 5527
	Clear Trasparente	17113 0030
	Frosted White Bianco Satinato	17113 1330
	Chrome Cromo	17113 4030
LED ↘ 3000 K ↘ 1 W/160 lm ↘ 350 mA ↘ CRI 90 ↘ MacAdam 3-Step LED and driver included LED e driver inclusi	Glossy Smoke Fumo Lucido	17113 4330
	Glossy Bronze ^{NEW} Bronzo Lucido	17113 4630
	Gold Oro	17113 5030
	Rose Gold Oro Rosa	17113 5530
	Clear Trasparente	17113 0030

Net weight/Peso netto: 0.8 kg

Pack/Coll: 2

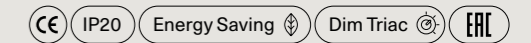

Suspension lamps must be installed on a canopy. Not suitable for the Radial System.

Le lampade a sospensione devono essere installate su rosone. Non utilizzabile sul Sistema Radiale.



Suspension lamps must be installed on a canopy. Not suitable for the Radial System.

Le lampade a sospensione devono essere installate su rosone. Non utilizzabile sul Sistema Radiale.

Random Solo, design by Chia-Ying Lee, 2020

Cluster suspension lamp

Random Solo 23

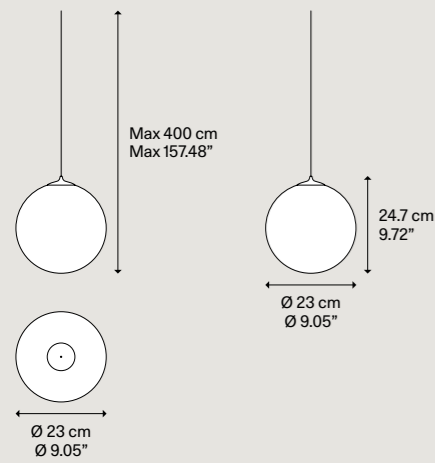

Light source Sorgente luminosa	Blown glass diffuser Diffusore in vetro soffiato	Code Codice	
LED ↘ 2700 K ↘ 3 W/450 lm ↘ 350 mA ↘ CRI 90 ↘ MacAdam 3-Step LED and driver included LED e driver inclusi	Clear Trasparente	17114 0027	
	Frosted White Bianco Satinato	17114 1327	
	Chrome Cromo	17114 4027	
	Glossy Smoke Fumo Lucido	17114 4327	
	Glossy Bronze ^{NEW} Bronzo Lucido	17114 4627	
	Gold Oro	17114 5027	
	Rose Gold Oro Rosa	17114 5527	
	or	Clear Trasparente	17114 0030
		Frosted White Bianco Satinato	17114 1330
		Chrome Cromo	17114 4030
Glossy Smoke Fumo Lucido		17114 4330	
LED and driver included LED e driver inclusi	Glossy Bronze ^{NEW} Bronzo Lucido	17114 4630	
	Gold Oro	17114 5030	
	Rose Gold Oro Rosa	17114 5530	

Net weight/Peso netto: 1.1 kg

Pack/Colli: 2

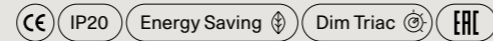

Random Solo, design by Chia-Ying Lee, 2020

Cluster suspension lamp

Random Solo 28

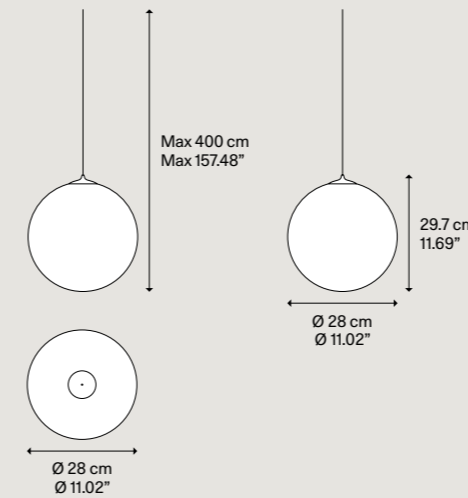

Light source Sorgente luminosa	Blown glass diffuser Diffusore in vetro soffiato	Code Codice	
LED ↘ 2700 K ↘ 3 W/450 lm ↘ 350 mA ↘ CRI 90 ↘ MacAdam 3-Step LED and driver included LED e driver inclusi	Clear Trasparente	17115 0027	
	Frosted White Bianco Satinato	17115 1327	
	Chrome Cromo	17115 4027	
	Glossy Smoke Fumo Lucido	17115 4327	
	Glossy Bronze ^{NEW} Bronzo Lucido	17115 4627	
	Gold Oro	17115 5027	
	Rose Gold Oro Rosa	17115 5527	
	or	Clear Trasparente	17115 0030
		Frosted White Bianco Satinato	17115 1330
		Chrome Cromo	17115 4030
Glossy Smoke Fumo Lucido		17115 4330	
LED and driver included LED e driver inclusi	Glossy Bronze ^{NEW} Bronzo Lucido	17115 4630	
	Gold Oro	17115 5030	
	Rose Gold Oro Rosa	17115 5530	

Net weight/Peso netto: 1.8 kg

Pack/Colli: 2

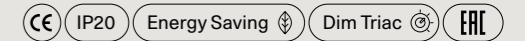

Suspension lamps must be installed on a canopy. Not suitable for the Radial System.

Le lampade a sospensione devono essere installate su rosone. Non utilizzabile sul Sistema Radiale.



Suspension lamps must be installed on a canopy. Not suitable for the Radial System.

Le lampade a sospensione devono essere installate su rosone. Non utilizzabile sul Sistema Radiale.

Lodes Product Configurator

Create truly unique combinations of light fixtures with *Lodes* canopies! Select a *lamp*, choose your *canopy* and create your customised *composition*.

Crea combinazioni di luci veramente uniche con i *rosoni* Lodes! Seleziona una *lampada*, scegli il tuo *rosone* e crea la tua *composizione* personalizzata.

STEP 1 Select your *lamp*:

Cluster suspension lamp

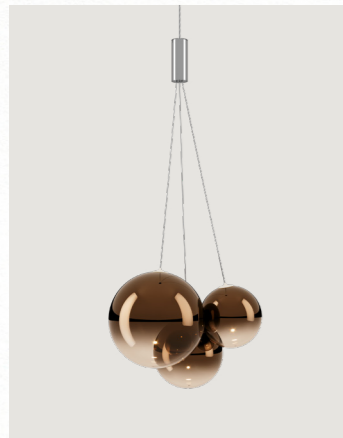

Random
Glossy Bronze NEW

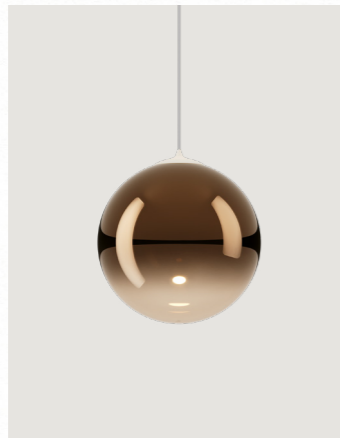

Random Solo
Glossy Bronze NEW *

STEP 2 Choose your *canopy*:

Single canopies



Standard

Mini

Recessed Micro

Multiple canopies

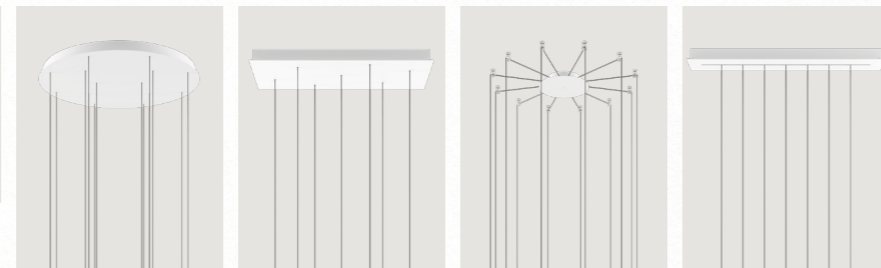

Round

Rectangular

Radial

Track

STEP 3 Create your *composition*:

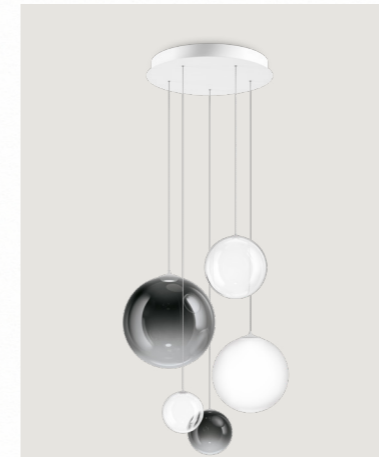

Random Solo, Round

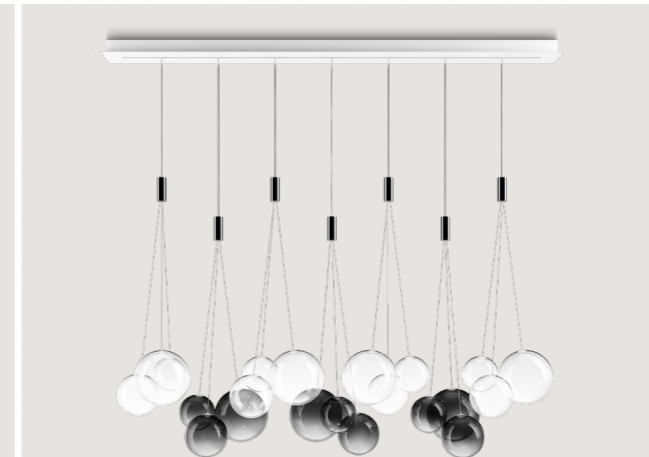

Random, Track



Random, Recessed Micro

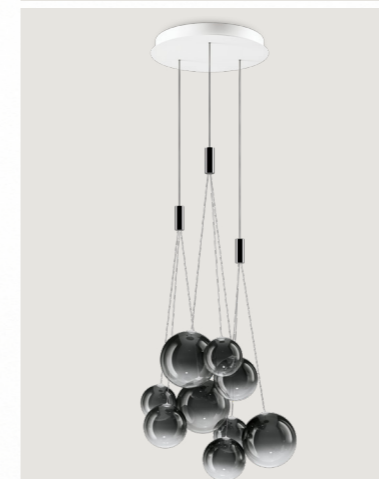

Random, Round

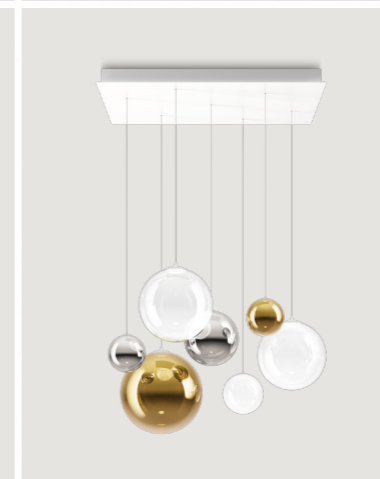

Random Solo, Rectangular

Canopies

Canopies are systems which allow to conceal the electrical joints of a light source, creating functional solutions to support the body of wall or ceiling suspension lights. *Lodes's canopies* are also a stand-out decorative element which helps to give individual light fixtures an original look and to make combinations of light fixtures truly unique.

Choose a product and create your own composition with *Lodes canopies*.

Rosoni

Sistemi che permettono di occultare i collegamenti elettrici di un punto luce, i *rosoni* sono soluzioni funzionali per sostenere i corpi luce a sospensione. I *rosoni Lodes* sono anche un elemento decorativo differenziante che contribuisce a rendere originali le singole lampade e uniche le loro combinazioni.

Scegli un prodotto e crea la tua composizione con i *rosoni Lodes*.

Discover more



Art. 1 Recital
Unless otherwise provided for in a separate written agreement between the parties, every sale of products of Lodes S.r.l., VAT 02992370276 (hereinafter, "the Seller") is governed by the following General Conditions of Sale that must be considered as an essential part of this agreement and shall be deemed to have been accepted by the Buyer even though the latter has not signed them. Any clause unilaterally added by the Buyer in the documentation signed by it and / or in its correspondence, being against or in any case in addition to the general conditions or to those specific expressly approved in writing by the Seller, shall be deemed as not written and shall be of no effect.

Art. 2 Completion of the sale, quantities and prices
The sale is deemed to be completed once the Seller gives the written order confirmation also by fax and / or email or when deliveries are commenced in cases where the immediate delivery of the supply is requested, also in consideration of changes occurred and then accepted by the customer. The prices agreed are understood for products delivered ex works of the Seller and do not include services and accessory charges (such as VAT, special packaging, transport and installation costs, and/or assemblages and so on).

Art. 3 Delivery, risk transfer and transport
Products are delivered to the Buyer at the Seller's plant or at another place indicated in writing by the Seller, and the risk transfer takes place with the delivery of the goods to the first carrier or Buyer in the events of collection of goods directly carried out by the latter. The products always travel at the Buyer's sole risk also when the carrier is selected and appointed by the Seller, being the latter freed from all responsibilities after having delivered the products to the carrier, this delivery is deemed to all effects being carried out directly by the said Buyer. The delivery terms agreed are to be understood as indicative. If the Seller is responsible for delay of delivery for a period of up to 60 days, the Buyer is not entitled either to refuse the supply or to request the termination of the agreement and / or the compensation for any damages. If the delay in delivery exceeds 60 days, the Buyer is entitled to request – by registered letter – the cancellation of the order and the reimbursement of the advances if paid. In any event, the Seller shall not be liable for and/or direct and indirect damages of any nature and for any reason due to the delay or the failure to carry out the supply.

Art. 4 Reservation of title
The Buyer acquires property rights over the goods with the full payment of the price invoiced of the supplies but it takes the risks thereof as of the delivery.

Art. 5 Products/features and conditions of use
Unless otherwise expressly agreed in writing by the parties, the conditions for using of the products are those communicated or in any case resulting from the drawings and technical specifications of the Seller, if any, or as described in the website www.lodes.com/en/in relation to products. The quality levels of products are the standard quality levels of the Sellers, indicated in the relevant specifications as described on the Seller's website. It is always the Buyer's responsibility to identify and notify the Seller of the conditions of use of products before technically defining them. Failing any particular instructions from the Buyer, the Seller considers as usual conditions of use those it considered or described in its designs and technical documentation.

Art. 6 Warranties
The products delivered are covered by a warranty for defects in material and manufacture for a period of 24 months as of the delivery if the Buyer is a natural person, otherwise the warranty period will be of 12 months as of the delivery. The Seller shall replace

the products delivered in this warranty period being faulty due to factory defects or in alternative, at its discretion, pay the Buyer an amount equal to the price already invoiced of the said products, being expressly excluded and waived any other right or claim by the Buyer also as compensation for direct and/or indirect damages or cost repayment borne by it (such as recovery, technical assistance, recalling costs, etc.). The Seller will anticipate the delivery of the replaced product, invoicing it regularly. Successively, when the product arrive to the Seller's warehouse, the latter will credit the amount of the defective product. The transport's costs will be paid by the Seller. Should the defected item be returned in an inadequate non-original packaging, with damages connected to the transport, The Seller will not credit any amount to the Buyer, and it will return the product to the sender at his own expenses. If the replacement was made for alleged defects in material and manufacture, but after the control carried out by the Seller, it is considered

(i) unfounded, due to the absence of defects; (ii) further damaged by insufficient packaging in the return transport (iii) spoiled by tampering made by the Buyer, all transportation costs and the entire value of the product will be charged to the latter. Any defectiveness or non-compliance of products shall be reported by the Buyer by writing to the Seller – in order to be valid – within 8 days from receipt of goods; any hidden defects shall be reported by the Buyer by writing to the Seller – always in order to be valid – within 8 days as of the relevant discovery. It being understood that the Seller will not be responsible for any defect even though hidden, being notified in writing, after 24 months of the delivery of goods. The warranty does not apply where the defects identified are due to the Buyer's negligence and / or to the use of products being not compliant with the information and explanations in any case gave by the Seller, technical provisions, to incorrect design, application, assembly or manufacture of the facilities in which they are installed, to incorrect maintenance carried out by unauthorized personnel, to improper cleaning since it is made with materials and manners being not suitable, to incorrect storage, handling and transport, to improper or imprudent use, also in the event of electrical system and its capacity being not suitable, or to circumstances that in any case cannot be related to the production defectiveness by the Seller. Every single product of the Seller corresponds to the mark laid down by the European Community with Directive 93 / 68 (extension of Directive 73 / 23) to confirm, with a mark recognized all over Europe, that the lights have undergone the electrical safety test required by European standards EN-60598-1-2 II ed. + CEI EN 60598-1 IV ed. corresponding to Italian standards CEI 34-21 + CEI 34-23, electrical safety standards referred to by all institutions, including the IMQ. The products indicated with the logo UL and/or ETL corresponds to the standards UL 1598 / CAN / USA C22.2 No.250.0 o UL 153.

Art. 7 Buyer's Obligations
The Buyer is required to immediately take delivery of the goods given by the Seller to the carrier, or – where otherwise agreed – to timely collect them at the Seller's plant on the date on which the Seller communicates, by any means, that the goods are ready. Where the Buyer delays the collection of the production for a period exceeding 10 days, in addition to the payment of price it shall pay the Seller a proper compensation equal to 2% per day of the price invoiced for storing such products. The Buyer shall carry out the payments normally, in accordance with the terms and conditions specified in the invoice. For late payments it will be accrued by default without need of further notification interest under Legislative Decree no. 231 / 2002. In the event of payment delays, the Seller is entitled to immediately suspend any supply, even though it has concluded other agreements with the same Buyer. The failure to pay within the terms agreed will cause in any event the loss of favourable terms for the Buyer.

Art. 8 Replacement of the Product
If a product is returned for commercial reasons or for a mistake in the order made by the Buyer, the Seller will retain an amount equal to the 20% of the total price as cost for reconditioning the product. If the returned product had already been used and / or it has been returned in an inadequate original packaging, with consequent transport damages, the Seller will not credit to the Buyer any amount and it will return the product to the sender at his own expenses. Only the articles in the catalogue and in the price list in force at the time of the request will be taken into consideration. Transport's costs are always charged to the Buyer. The repair of damaged products will be authorized only if the damage has been caused by the Buyer. The Buyer, once accepted repair costs, will take care of returning the damaged product to the Seller's warehouse and it will pay the costs of transporting the repaired product.

Art. 9 Force majeure
If the Seller is unable to comply with the agreement due to force majeure or beyond its control events, the deadlines set for the supply are automatically extended for a period in which these effects continue. Where the obstacle to comply with the agreement is longer than 6 months, both parties may request the termination of the agreement and, in such event, the Seller repay the Buyer the advances received, if any, releasing itself from any additional obligation on it.

Art. 10 Agreement
In the event of execution of a specific agreement signed by the parties, the said agreement together with its Annexes provides for and summarizes the obligations validly undertaken by the parties and being binding for them. The fulfilment by the parties will be subject to effective evaluation of the actual performance of the contractual tasks and duties to be carried out in good faith, with honesty and fairness. These General Conditions of Sale shall apply to the agreement, unless otherwise provided in writing by the parties or expressly provided in the said agreement.

Art. 11 Privacy Policy
The Seller will use the data received from the Buyer in accordance with the provisions of the article 13 of EU Regulation 2016 / 679 of 27 April 2016 (GDPR). For more information are available at the following link: www.lodes.com/en/terms-and-conditions/.

Art. 12 Disputes
Any dispute which may arise concerning the signing, validity, interpretation, performance, amendment and termination of the agreement or of these General Conditions of Sale will be settled according to principles and rule set forth in Article 13 below.

Art. 13 Jurisdiction and Applicable Law
The Court of Milan, Italy, shall be held exclusively competent, being any other court of competent jurisdiction expressly excluded, and the Italian Law shall be applicable.

Art. 14 Website
These General Conditions of Sale are those indicated on the website www.lodes.com/en/ and may be printed and reproduced on paper. The Seller undertakes to update the website www.lodes.com/en/ by publishing on it the version of the General Conditions of Sale as amended from time to time.

Art. 1 Premessa
Salvo deroga risultante da apposito accordo scritto tra le parti, ogni compravendita di prodotti di Lodes S.r.l., P.IVA 02992370276 (di seguito: "Venditore") è regolata dalle seguenti Condizioni Generali di Vendita che costituiscono parte essenziale del contratto e che si intendono pertanto accettate dal Compratore ancorché dallo stesso non sottoscritte. Qualsiasi clausola unilateralmente apposta dal Compratore nei documenti da lui sottoscritti e/o nella sua corrispondenza, che sia contraria o comunque in aggiunta alle seguenti condizioni generali od a quelle speciali espressamente approvate per iscritto dal Venditore, si intende come non scritta ed è priva di ogni effetto.

Art. 2 Perfezionamento della compravendita, quantitativi e prezzi
La compravendita si intende perfezionata con la conferma d'ordine scritta del Venditore anche a mezzo fax e/o posta elettronica o con l'inizio delle consegne per i casi in cui è stata richiesta l'immediata consegna della fornitura anche in presenza di modifiche intervenute e quindi accettate dal cliente. I prezzi concordati si intendono per prodotti consegnati franco stabilimento del Venditore e non comprendono prestazioni ed oneri accessori (quali IVA, imballo speciale, spese di trasporto, di installazione e/o montaggi e così via).

Art. 3 Consegna, trasferimento del rischio e trasporto
La merce viene consegnata al Compratore presso lo stabilimento del Venditore o in altro sito dallo stesso indicato per iscritto, ed il trasferimento del rischio avviene con la consegna della stessa al primo vettore o al Compratore nelle ipotesi di ritiro della merce da quest'ultimo direttamente eseguita. La merce viaggia sempre a rischio esclusivo del Compratore anche quando il vettore dovesse essere scelto ed incaricato dal Venditore, essendo quest'ultimo liberato da ogni responsabilità con la consegna dei prodotti al vettore, che ad ogni effetto si intende eseguita a mani dallo stesso Compratore. I termini di consegna pattuiti si intendono indicativi. In caso di ritardo nella consegna imputabile al Venditore per un periodo fino a 60 gg il Compratore non ha il diritto di rifiutare la fornitura, né di richiedere la risoluzione del contratto e / o il risarcimento di alcun danno. Se il ritardo nella consegna supera il termine di 60 gg il Compratore ha la facoltà di richiedere – con lettera raccomandata – l'annullamento dell'ordine e la restituzione degli anticipi eventualmente versati. Resta in ogni caso escluso qualsivoglia obbligo del Venditore di risarcimento danni diretti e / o indiretti di qualsiasi natura e per qualsiasi ragione, in dipendenza del ritardo ovvero della mancata esecuzione della fornitura.

Art. 4 Riserva di proprietà
Il Compratore acquista la proprietà della merce solo con il pagamento integrale del prezzo fatturato delle forniture ma ne assume i rischi dal momento della consegna.

Art. 5 Caratteristiche dei prodotti e condizioni di utilizzo
Salvo diverso ed espresso accordo scritto tra le parti, i parametri funzionali dei prodotti sono quelli espressi comunicati o comunque risultanti nei disegni e specifiche tecniche del Venditore se esistenti o su quanto indicato sul sito web www.lodes.com relativamente ai prodotti. I livelli di qualità dei prodotti forniti sono quelli standard del Venditore, evidenziati nelle relative specifiche o su quanto indicato e desumibile sul sito web del Venditore. È onere del Compratore individuare e comunicare al Venditore le condizioni di utilizzo dei prodotti prima della relativa definizione tecnica. In mancanza di indicazioni da parte del Compratore il Venditore considera condizioni di utilizzo quelle di prassi dallo stesso considerate o esplicitate nei propri disegni e documentazione tecnica.

Art. 6 Garanzie
I prodotti forniti sono coperti da garanzia per difetti di materiale e / o fabbricazione per un periodo di 24 mesi dalla consegna se il Compratore risulta essere una persona fisica, diversamente il periodo di garanzia sarà di 12 mesi dalla consegna. Il Venditore sostituisce i prodotti resi in detto periodo di garanzia e riconosciuti difettosi per vizi d'origine ovvero in alternativa ed a sua scelta accreditata al Compratore una somma pari al prezzo già fatturato dei prodotti stessi, restando espressamente escluso e rinunciato qualsiasi diverso diritto o pretesa del Compratore anche a titolo di risarcimento danni diretti e/o indiretti o di rimborso di costi dallo stesso sostenuti (quali costo di riprese, di assistenza tecnica, di richiamo, ecc.). Il Venditore anticiperà l'invio del prodotto in sostituzione, fatturandolo regolarmente, andando poi ad accreditare l'importo alla riconsegna del prodotto difettoso reso. Le spese di trasporto saranno a carico del Venditore. Qualora l'articolo oggetto del reso venisse riconsegnato in un imballo non originale inadeguato con conseguenti danni da trasporto, il Venditore non accrediterà al Compratore alcun importo e rinverrà al mittente, a sue spese il prodotto. Qualora il reso venisse effettuato per presunti vizi d'origine ma dopo il controllo effettuato dal Venditore lo stesso venisse ritenuto (i) infondato, per assenza di vizi; (ii) ulteriormente danneggiato da insufficiente imballaggio nel trasporto di ritorno (iii) viziato da manomissione posta in essere dal Compratore, verranno addebitati a quest'ultimo tutti i costi di trasporto nonché l'intero valore del prodotto. Eventuali difettosità o non conformità dei prodotti devono essere segnalate dal Compratore per iscritto al Venditore – a pena di decadenza – entro e non oltre 8 gg dalla data di ricevimento della merce; eventuali difetti occulti devono essere segnalati dal Compratore per iscritto al Venditore – sempre a pena di decadenza – entro 8 gg dalla relativa scoperta. Resta inteso che il Venditore non sarà responsabile per alcun vizio ancorché occulto, comunicato per iscritto, oltre 24 mes i dalla consegna della merce. La garanzia non opera ove i difetti rilevati siano imputabili a negligenza del Compratore e / o ad impiego dei prodotti non conforme con le informazioni e le spiegazioni in ogni caso fornite dal Venditore, alle prescrizioni tecniche, ad errata progettazione, applicazione, montaggio o fabbricazione delle strutture ove sono installati, ad errata manutenzione operata da personale non autorizzato, a pulizia impropria in quanto effettuata con modalità o materiali non idonei, ad errato magazzinaggio, movimentazione e trasporto, ad uso improprio od incauto, anche in caso di impianto elettrico e portata dello stesso non idonea, ovvero a circostanze che comunque non possono ricollegarsi a difettosità di produzione da parte del Venditore. Ogni singolo prodotto del Venditore è conforme alla marcatura richiesta dalla Comunità Europea con la direttiva 93/68 (ampliamento della direttiva 73/23) per confermare con una marcatura riconosciuta in tutta Europa, che le lampade sono state sottoposte alle prove di sicurezza elettrica richieste dalle norme Europee EN-60598-1-2 II ed. + CEI EN 60598-1 IV ed. corrispondenti norme italiane CEI 34-21 + CEI 34-23, norme per la sicurezza elettrica a cui fanno riferimento tutti gli istituti, compreso l'IMQ. I prodotti indicati con il marchio UL e / o ETL sono conformi alla normativa UL 1598 / CAN / USA C22.2 No.250.0 o UL 153.

Art. 7 Obblighi del Compratore
Il Compratore è tenuto a prendere immediatamente in consegna i prodotti affidati dal Venditore al vettore, ovvero – se diversamente concordato – a puntualmente ritirarli presso lo stabilimento del Venditore alla data di comunicazione di merce pronta che potrà avvenire con ogni mezzo da parte del Venditore. Ove il Compratore ritardi il ritiro dei prodotti per un periodo superiore a 10 gg, oltre al pagamento del prezzo deve corrispondere al Venditore un adeguato compenso pari al 2% al giorno dell'importo fatturato per il magazzinaggio degli stessi. Il Compratore deve effettuare i pagamenti normalmente, con le modalità e nei termini precisati in fattura. Sui ritardati pagamenti decorreranno, di pieno diritto e senza necessità di costituzione in mora, gli

interessi di cui al D.lgs. n. 231 / 2002. In caso di ritardo dei pagamenti il Venditore ha diritto a sospendere immediatamente ogni fornitura, anche se dipendente da altri contratti con lo stesso Compratore. Il mancato pagamento nei termini pattuiti comporta in ogni caso la decadenza del Compratore dal beneficio del termine.

Art. 8 Resi
In caso di reso commerciale o in caso di reso per errore del Compratore, il Venditore tratterà un importo pari al 20% minimo del totale a titolo di costo di ricondizionamento dell'articolo. Qualora l'articolo oggetto del reso fosse già stato utilizzato e / o venisse riconsegnato in un imballo non originale inadeguato, con conseguenti danni da trasporto, il Venditore non accrediterà al Compratore nessun importo e rinverrà al mittente, a sue spese, il reso. Verranno presi in considerazione solamente gli articoli presenti nel catalogo e nel listino in vigore al momento della richiesta. Le spese di trasporto sono sempre a carico del Compratore. I resi per riparazione vanno autorizzati solo se la causa del danno è dipesa dal Compratore che dopo aver accettato il costo di riparazione si occuperà a proprie spese di rispedire l'articolo danneggiato in sede e si accollerà poi i costi relativi al trasporto del prodotto riparato.

Art. 9 Forza maggiore
Qualora il Venditore sia impossibilitato a rispettare il contratto per cause di forza maggiore o comunque indipendenti dalla sua volontà, i termini previsti per l'esecuzione della fornitura sono automaticamente prorogati per un periodo equivalente al perdurare degli effetti di tali cause. Qualora la causa impeditiva continui per più di 6 mesi entrambe le parti possono chiedere la risoluzione del contratto ed in tal caso il Venditore restituisce al Compratore gli anticipi eventualmente ricevuti, con esclusione di ogni e qualsiasi onere ulteriore a suo carico.

Art. 10 Contratto
In caso di sottoscrizione di apposito contratto lo stesso con i suoi allegati contiene e riassume le obbligazioni validamente assunte dalle parti e per esse vincolanti. L'adempimento delle parti sarà oggetto di valutazione dell'effettiva esecuzione dei compiti e doveri contrattuali, da effettuarsi in buona fede, onestà e con equità. Le presenti Condizioni Generali di Vendita si applicheranno al contratto salvo deroga risultante da atto scritto o in esso contratto esplicitamente prevista.

Art. 11 Trattamento dei Dati Personali
Il Venditore utilizzerà i dati ricevuti dal Compratore conformemente alle disposizioni vigenti in materia di Privacy secondo l'art. 13 del Regolamento Europeo 2016 / 679 (GDPR). Maggiori informazioni sono disponibili al seguente link: www.lodes.com/area-legale/.

Art. 12 Controversie
Qualora dovesse verificarsi una qualsivoglia controversia avente ad oggetto la formazione, validità, interpretazione, esecuzione, modifica e risoluzione del contratto o delle presenti Condizioni Generali di Vendita, questa sarà risolta secondo i principi e le regole indicate nell'articolo 13 che segue.

Art. 13 Foro competente e legge applicabile
Foro esclusivamente competente sarà quello di Milano con esplicita esclusione di ogni altro foro alternativamente competente, e la legge applicabile quella italiana.

Art. 14 Sito Web
Le presenti Condizioni Generali di Vendita, sono quelle risultanti sul sito web www.lodes.com e sono stampabili e riproducibili su supporto cartaceo. Il Venditore si impegna ad aggiornare il sito web www.lodes.com mediante la pubblicazione sullo stesso della versione di Condizioni Generali di Vendita di volta in volta modificata.

Head offices & showroom

Lodes, via Pialoi 32,
30020 Marcon (Venezia) Italy
T +39 041 45 69 266

General information
info@lodes.com

2023 Preview

*Art direction
and graphic design*
Think Work Observe

Images
Bruger Studio

Copywritings
Lodes

*Colour separation
and printing*
Grafiche Antiga

Lodes Milan showroom

via della Moscova 33,
Cortile della Seta
20121 Milano (MI) Italy
T +39 02 4940 0999
milano@lodes.com

Lodes Flagship

Paris
Novaluce S.a.r.l.
131 Rue du Faubourg
Saint-Honoré
75008 Parigi, Francia
T +33 142 890 318
paris@lodes.com

Doha
Abensal Lighting
C-Ring Road, St. 230
Zone 41, Building no. 245
Al Hilal – Doha, Qatar
T +974 4016 4866
qatar@abensal.com

2023 Preview
lodes.com